

# Laser Parts Locator

# Laser Sails

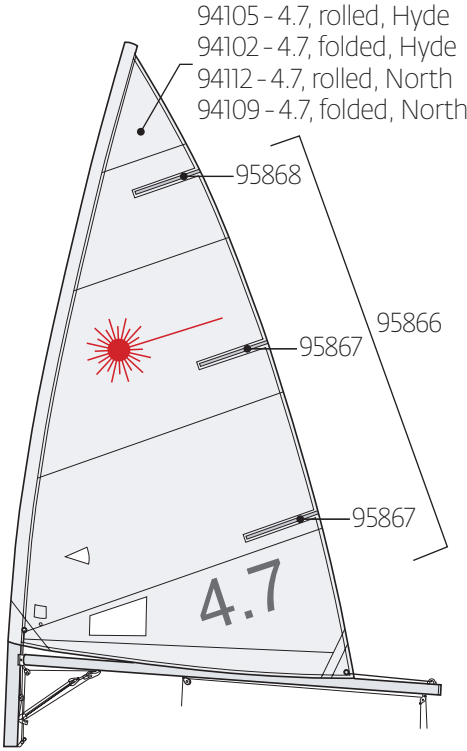
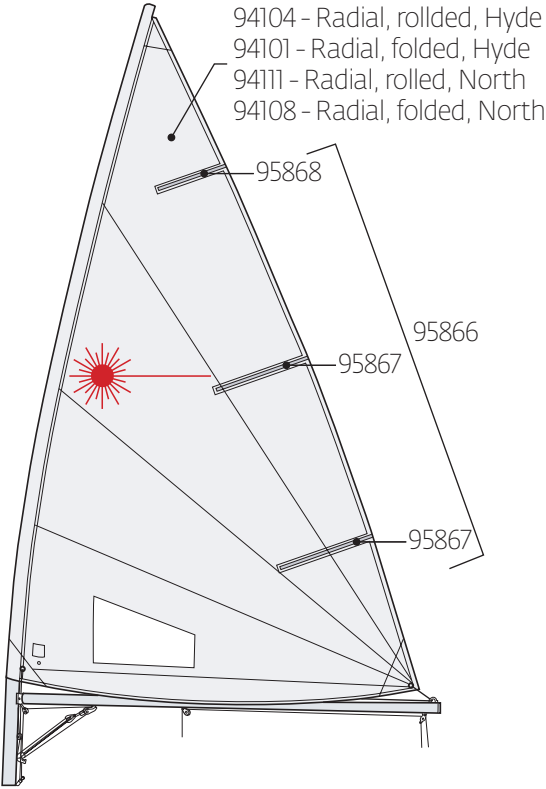
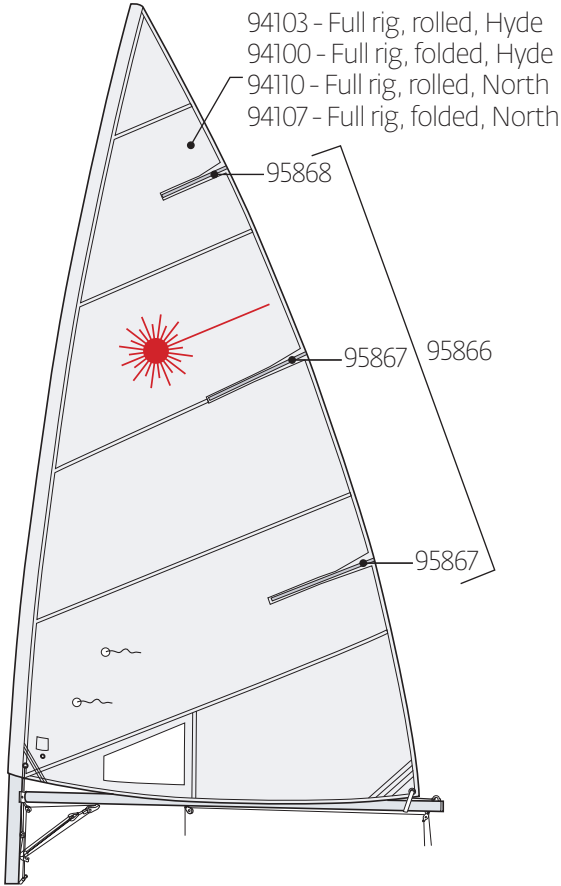
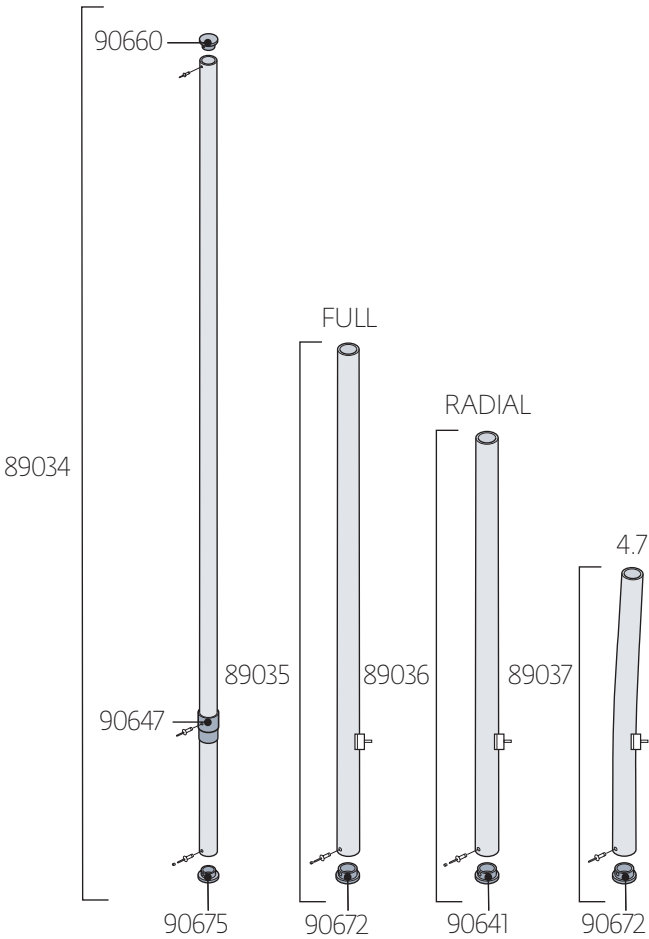

- SAIL NUMBERS  
 95843 9in, blue  
 95844 9in, red  
 95845 12in, blue  
 95846 12in, red  
 95853 12in, black

- SAIL BAGS  
 95801 4.7 sailbag, white  
 95802 Radail sailbag, red  
 95803 Full rig sailbag, blue  
 95869 Batten tips

# Laser Deck

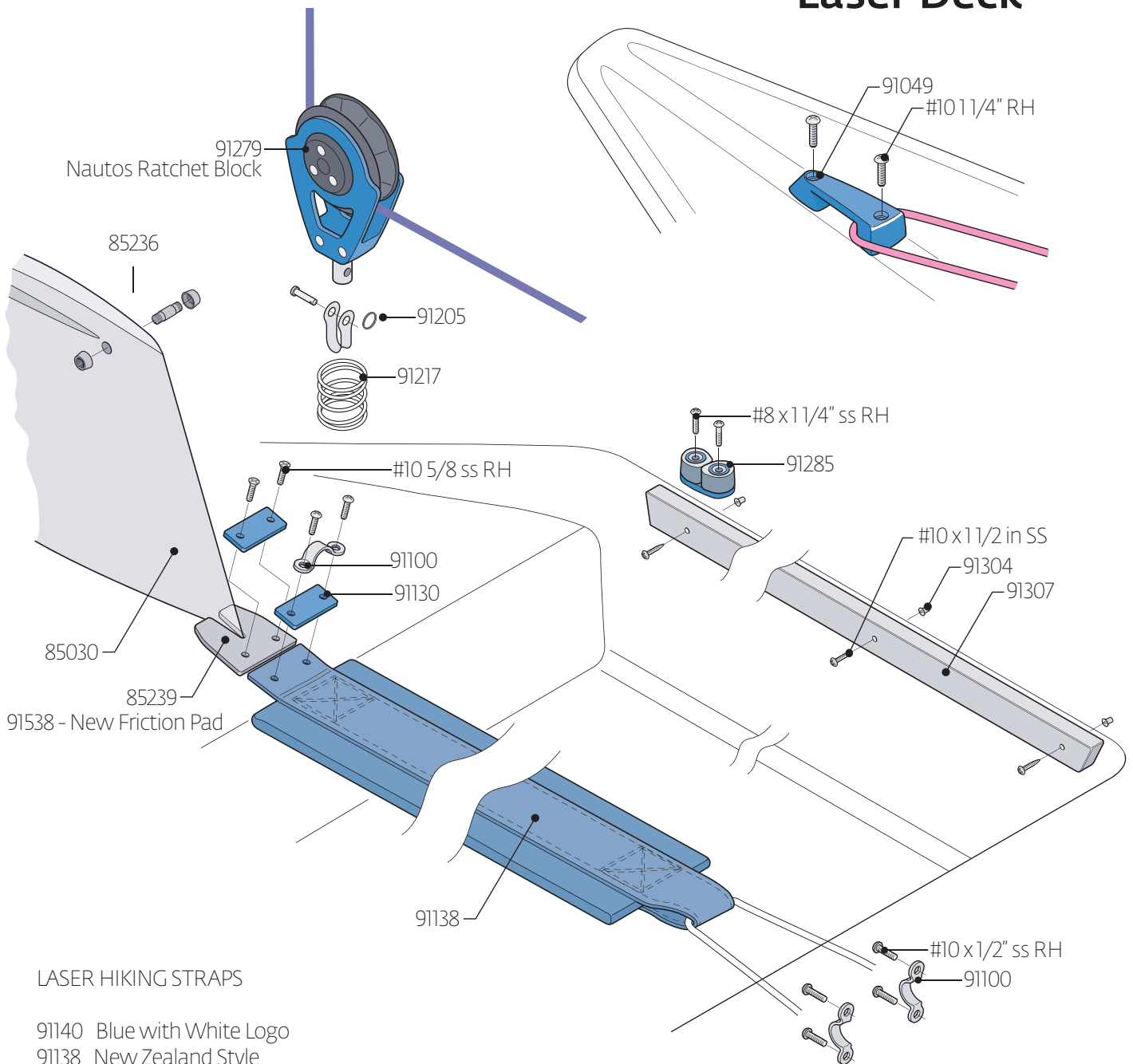

## LASER HIKING STRAPS

- 91140 Blue with White Logo
- 91138 New Zealand Style
- 91139 Black nylon webbing
- 91141 Grey 5in
- 91142 Seitech strap
- 91143 White with Blue Logo
- 91293 XD style
- 91432 Blue with White Logo

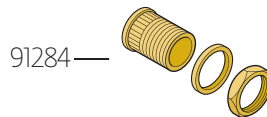

## 91009 Complete Bailer Assembly

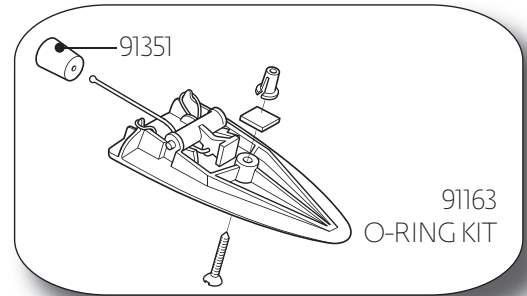

91351 Drain Bung Only



# Laser XD Deck

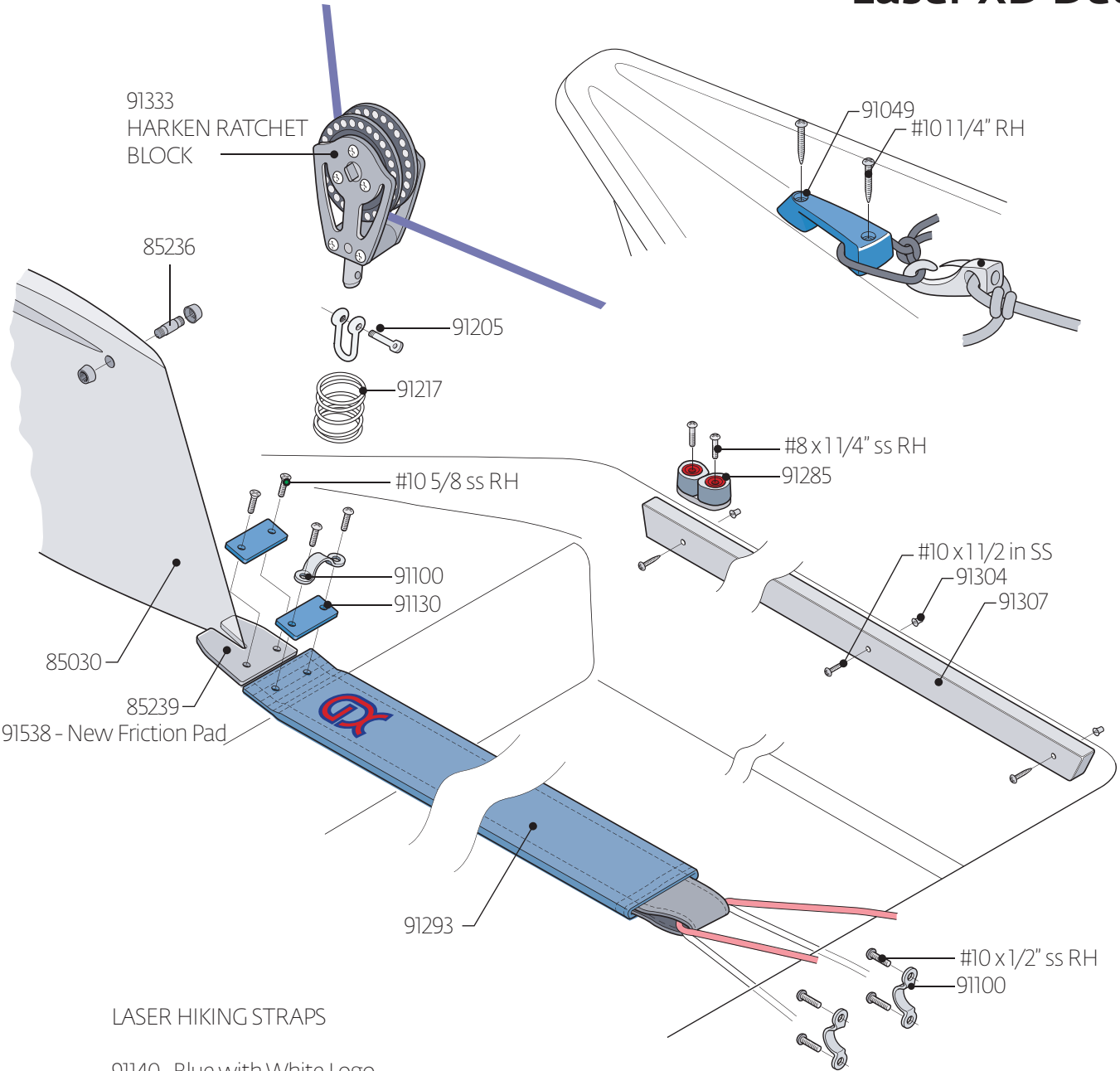

LASER HIKING STRAPS

- 91140 Blue with White Logo
- 91138 New Zealand Style
- 91139 Black nylon webbing
- 91141 Grey 5in
- 91142 Seitech strap
- 91143 White with Blue Logo
- 91293 XD style
- 91432 Blue with White Logo

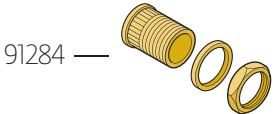

91009 Complete Autobailer

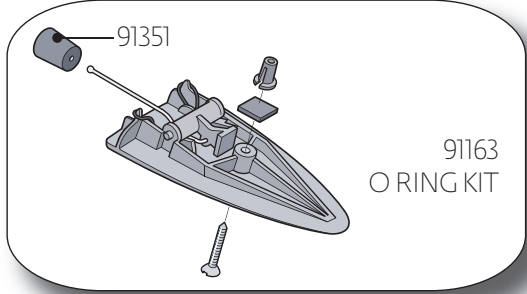

91351 Drain Bung Only

# Laser Outhaul

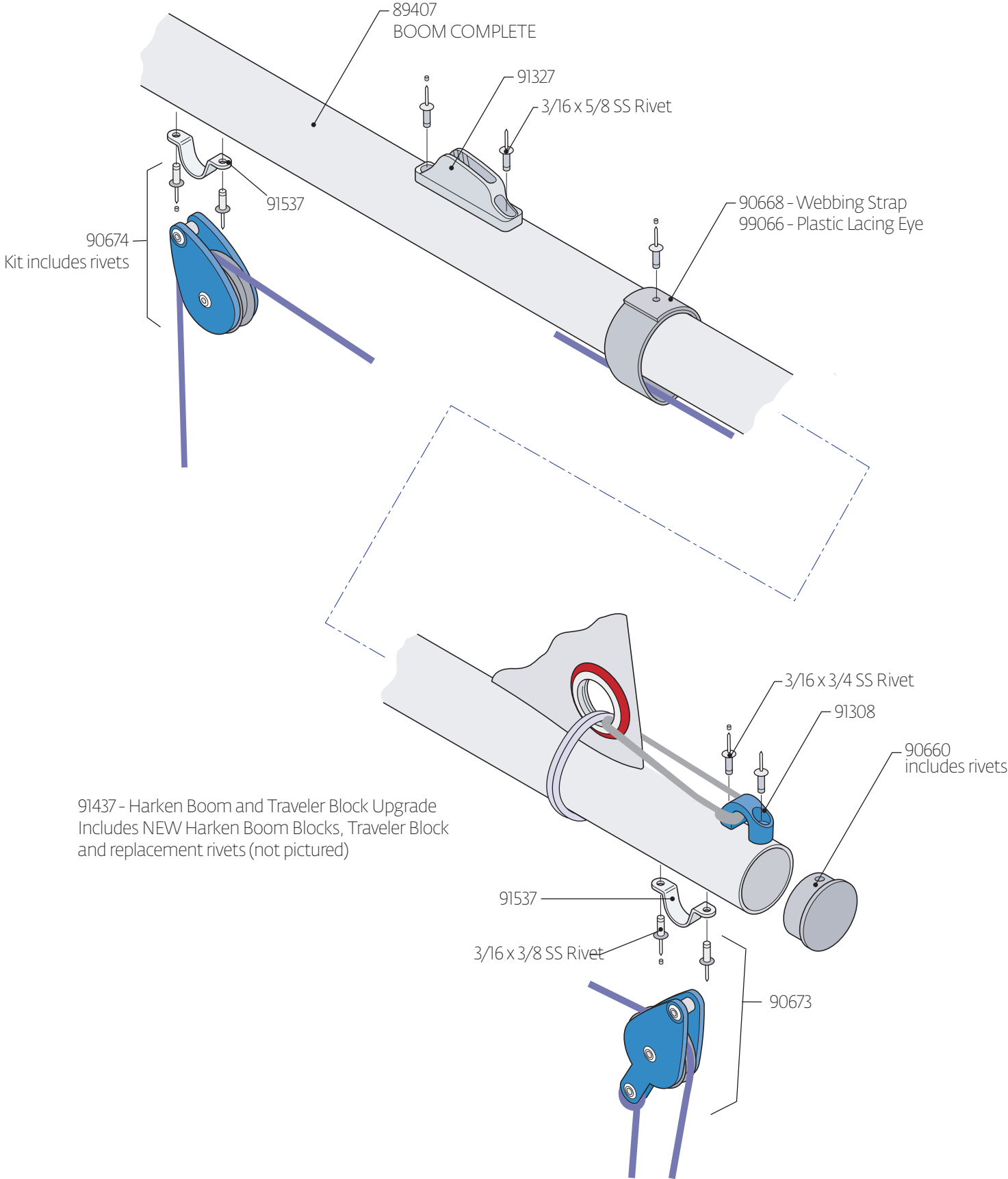

# Laser Race Outhaul

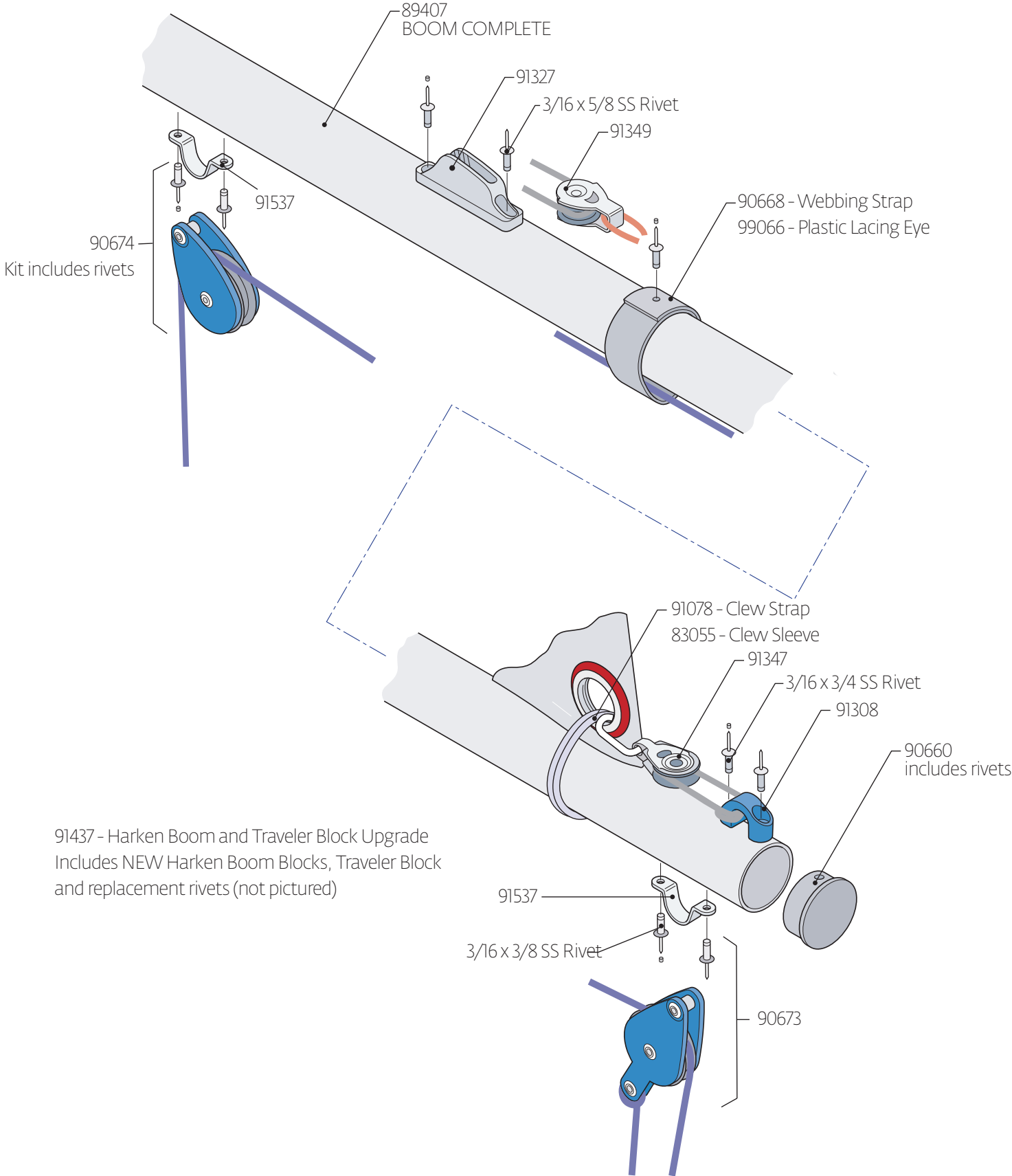

91437 - Harken Boom and Traveler Block Upgrade  
Includes NEW Harken Boom Blocks, Traveler Block  
and replacement rivets (not pictured)

# Laser XD Outhaul

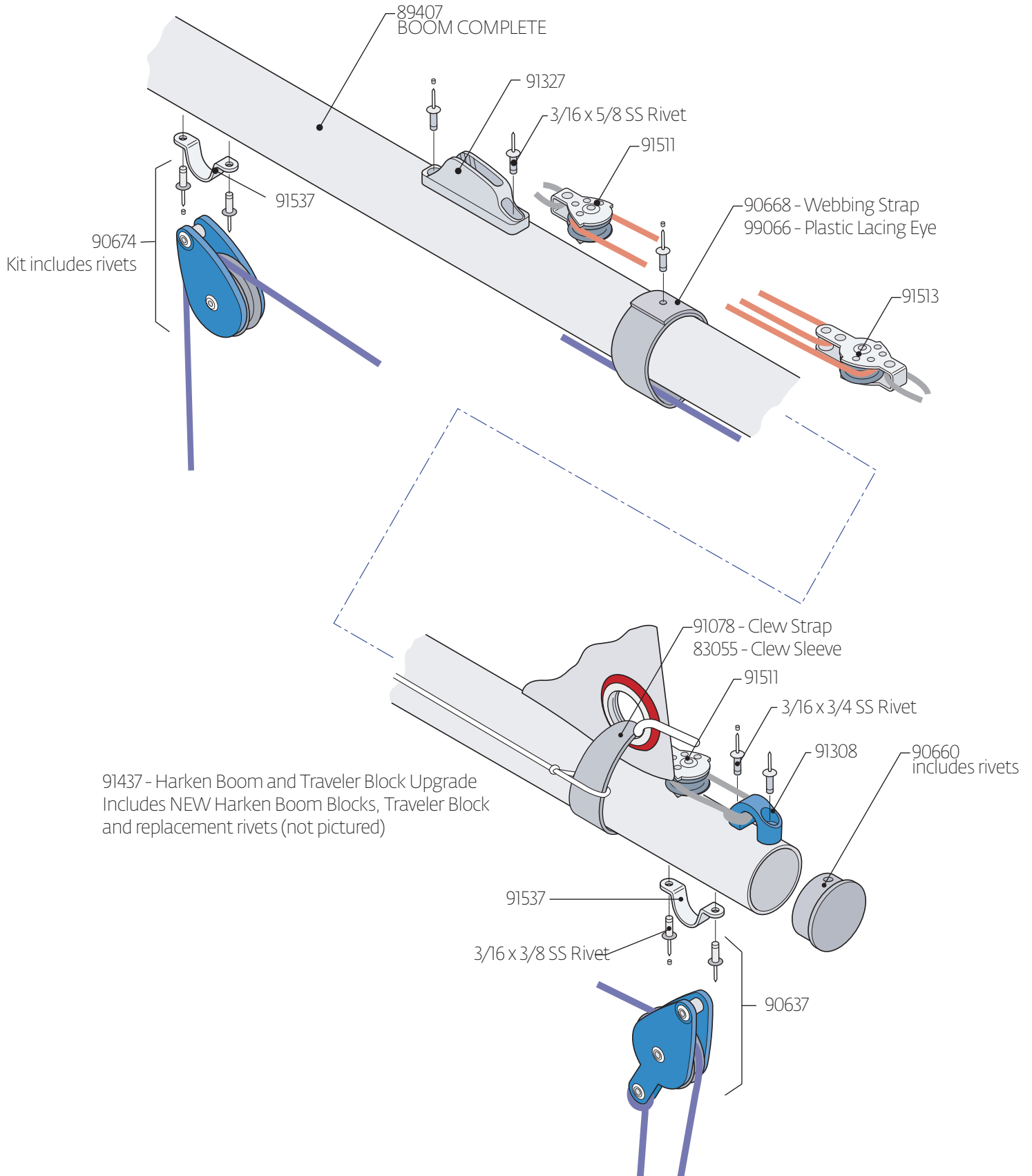



# Laser Gooseneck

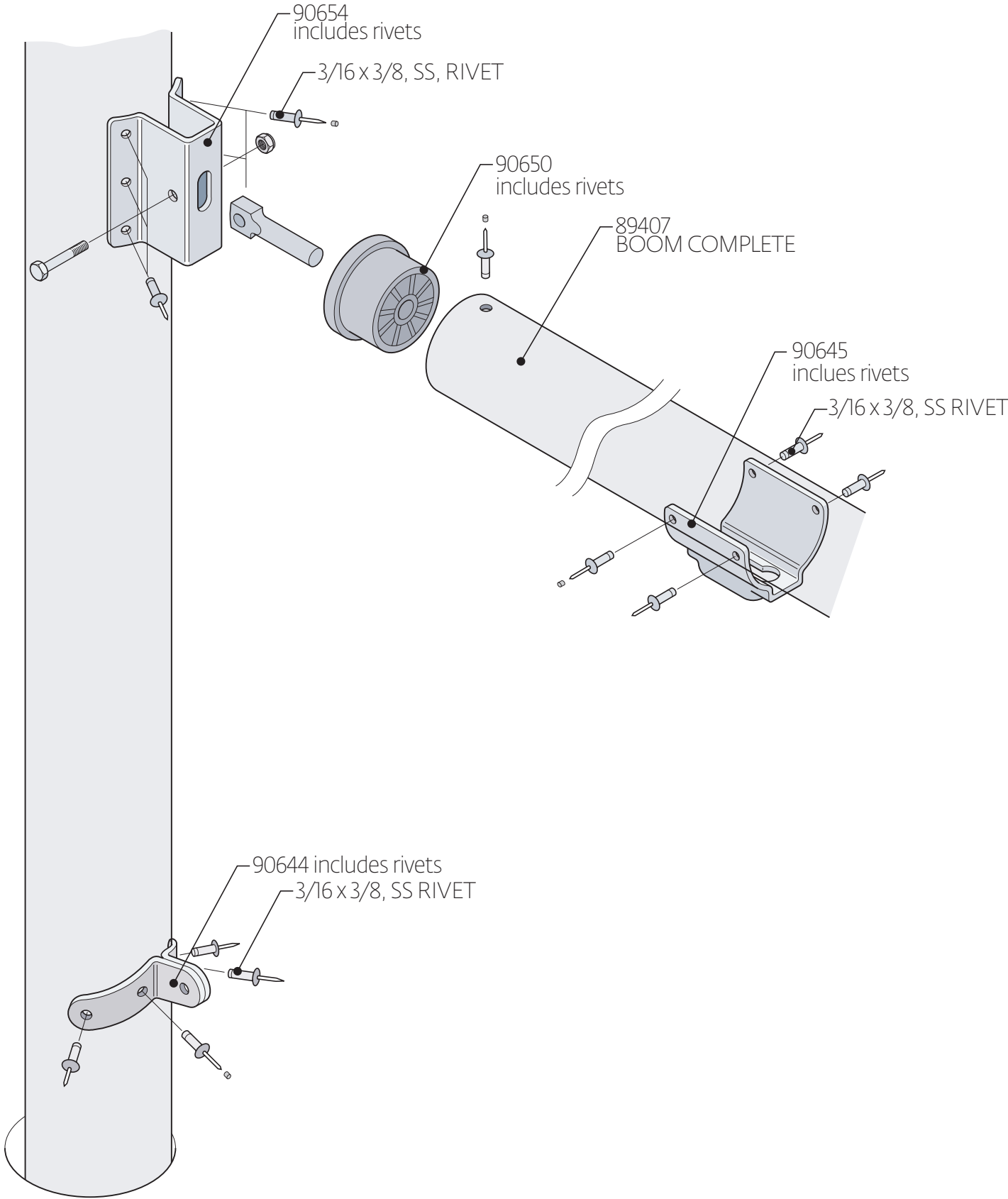

# Laser Vang

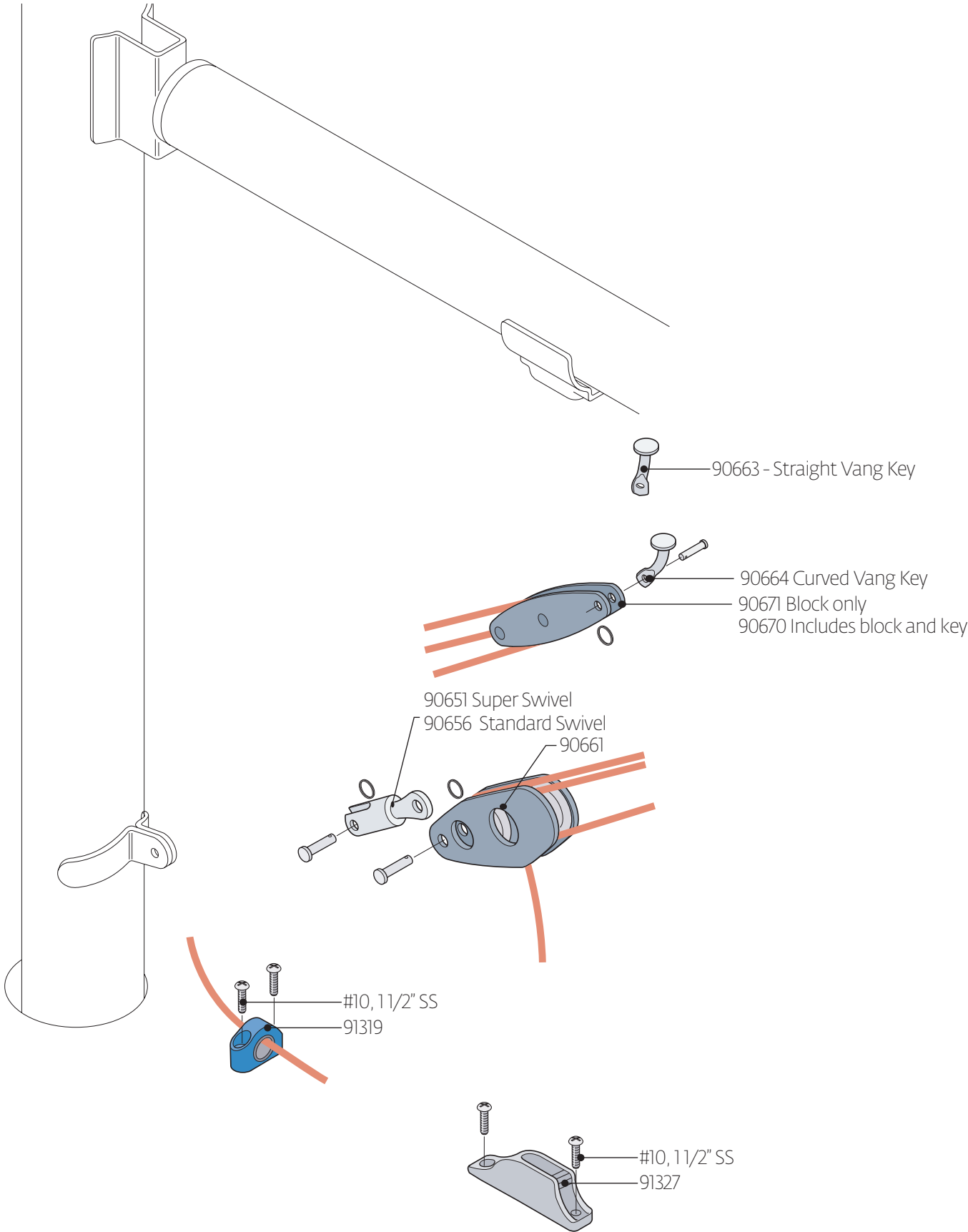

# Laser Race Vang

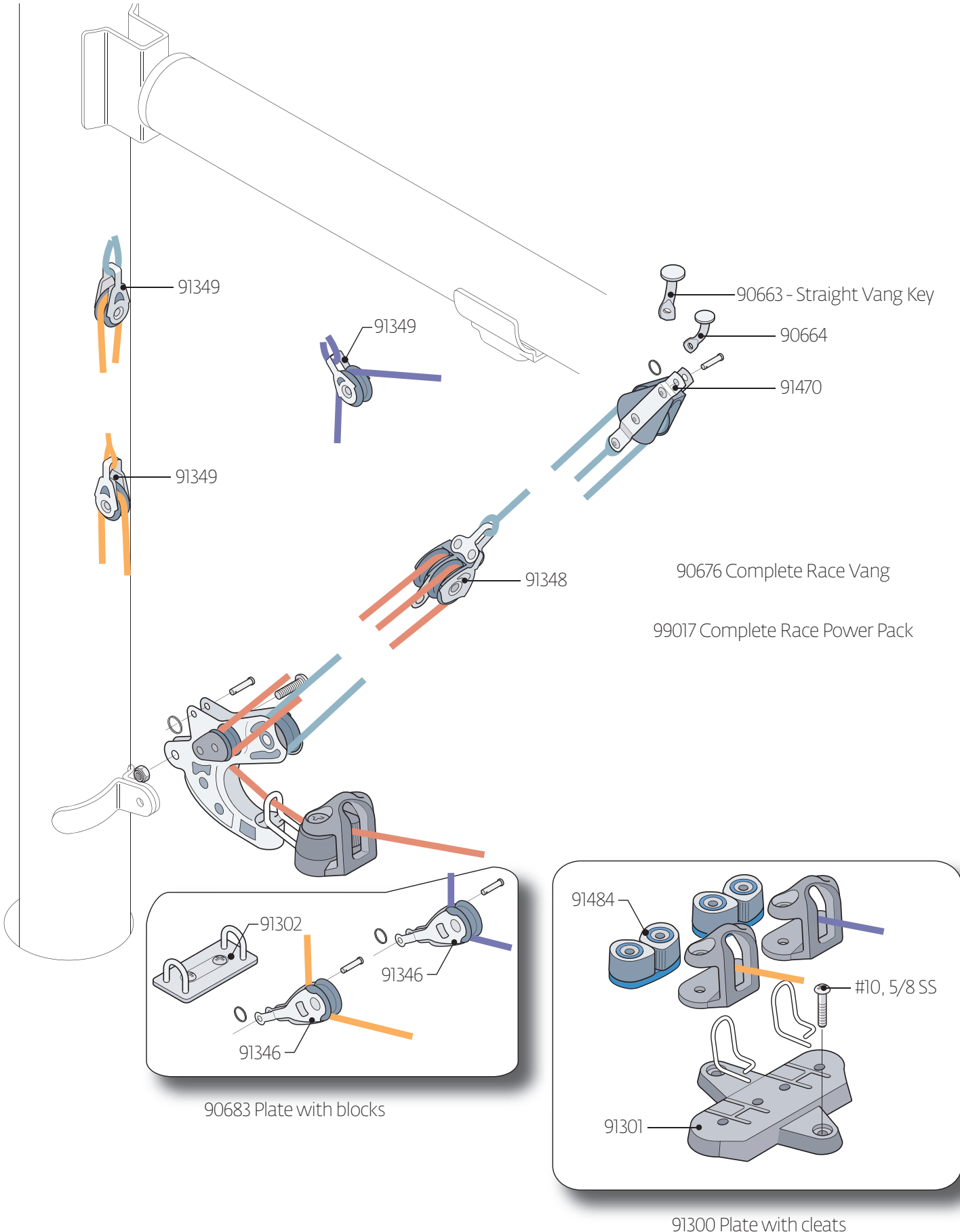



# Laser Rudder

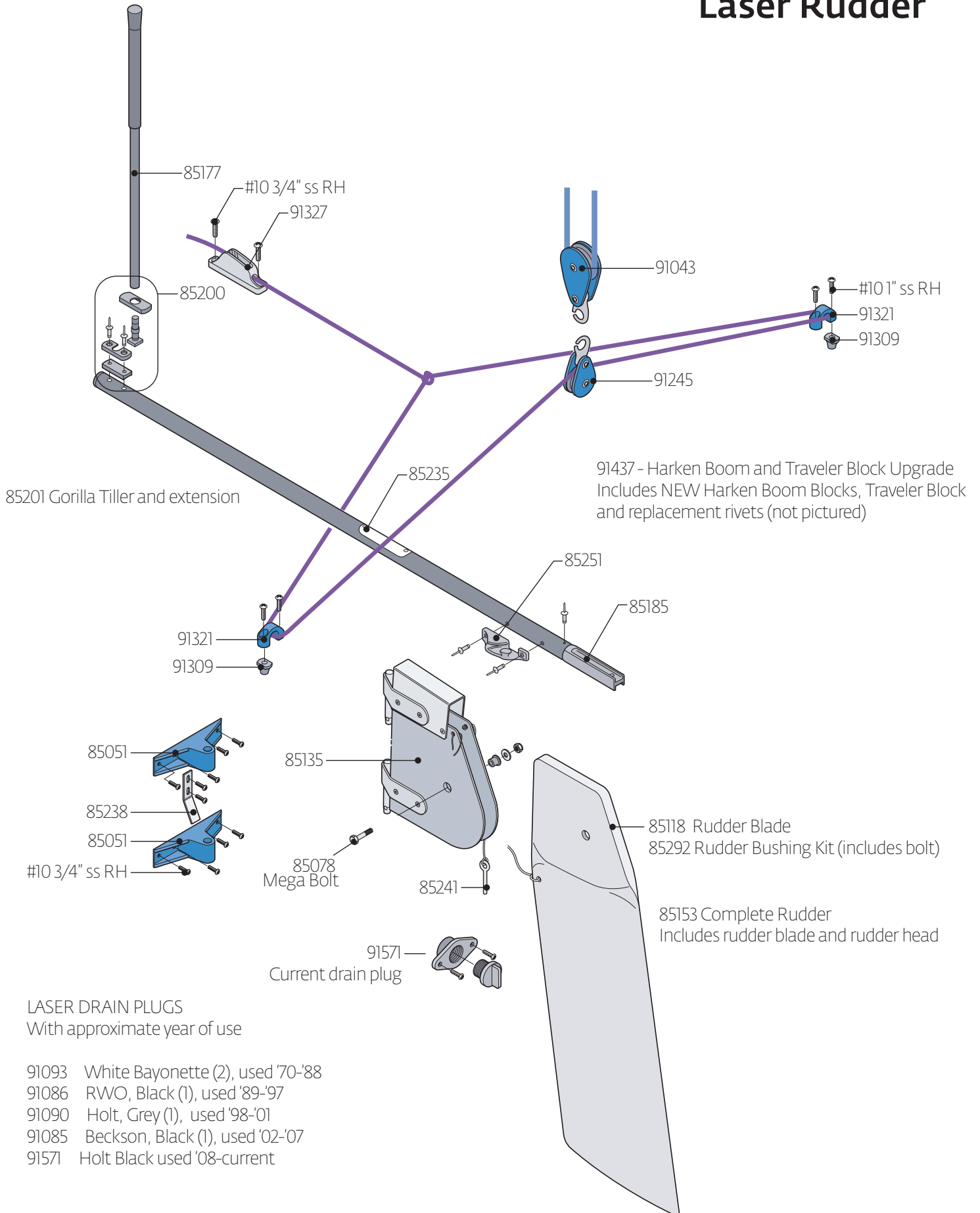

LASER DRAIN PLUGS  
With approximate year of use

- 91093 White Bayonette (2), used '70-'88
- 91086 RVO, Black (1), used '89-'97
- 91090 Holt, Grey (1), used '98-'01
- 91085 Beckson, Black (1), used '02-'07
- 91571 Holt Black used '08-current

# Laser XD Rudder

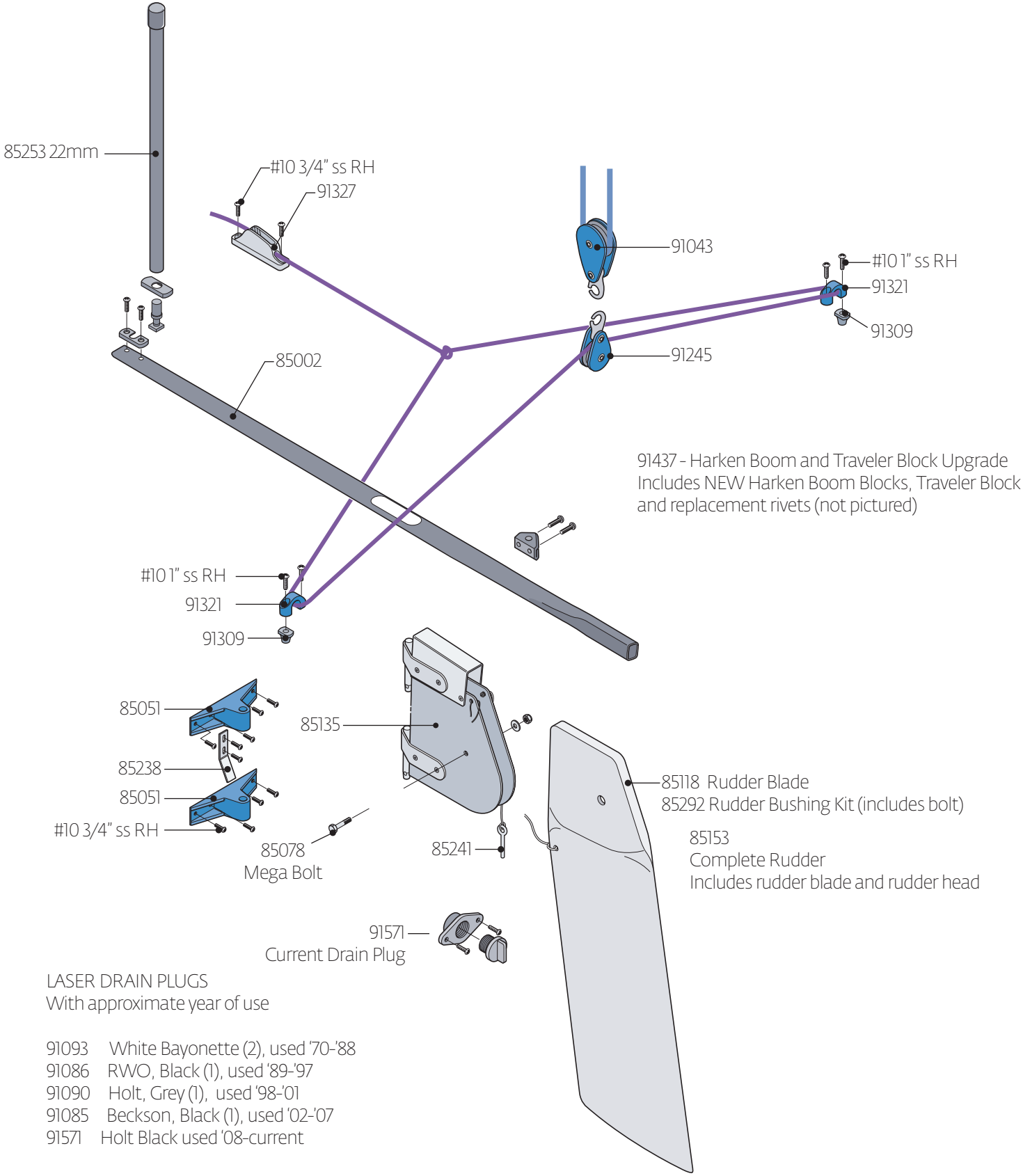

LaserPerformance NORTH AMERICA  
300 Highpoint Avenue  
Portsmouth, Rhode Island 02871  
USA  
t +1 800 966 SAIL  
f +1 401 683 0990

LaserPerformance EUROPE  
Station Works, Long Buckby  
Northamptonshire NN6 7PF  
United Kingdom  
t +44 (0) 1327 841600  
f +44 (0) 1327 841601

LaserPerformance ASIA  
Room 3415  
China Merchants Tower  
Shun Tak Centre  
No. 168-200 Connaught Road Central  
Hong Kong  
t +852 2902 2818  
f +852 2587 7868

LaserPerformance MIDDLE EAST  
Dubai Investment Park  
po box 38442  
Dubai, UAE  
t +9714 885 7601

[LASERPERFORMANCE.COM](http://LASERPERFORMANCE.COM)

All rights reserved. ©2010 LaserPerformance. LaserPerformance and associated logos are trademarks. Laser, SB3, Sunfish, and Dart are trademarks used under license. LaserPerformance reserves the right to make design and/or specification changes to any of their products as part of their continuous development program.